

CRAFTMADE LIGHTING

ASSEMBLY & INSTALLATION INSTRUCTIONS FOR #44934-GT

Please read carefully and save these instructions, as you may need them at a later date.

CAUTION

Turn off the main power at the circuit breaker before installing the fixture, in order to prevent possible shock.

GENERAL

All electrical connections must be in accordance with local and National Electrical Code (N.E.C.) standards. If you are unfamiliar with proper electrical wiring connections obtain the services of a qualified electrician.

Remove the fixture and the mounting package from the box and make sure that no parts are missing by referencing the illustrations on the installation instructions.

ASSEMBLY AND INSTALLATION

- Take the parts out of the mounting package. Screw the end of the NIPPLE (4) into the center hole of the MOUNTING BRACKET (2) and thread both 1/8" IPS HEX NUT(5) several turns onto each end of the NIPPLE(4) but do not tighten the 1/8" IPS HEX NUTS (5). Pull the SUPPLY WIRES (9 & 11) and the SUPPLY GROUND WIRE (8) out from the OUTLET BOX (1) and attach the MOUNTING BRACKET (2) assembly to the OUTLET BOX (1) using the slotted holes of the MOUNTING BRACKET (2) and the MOUNTING SCREWS (3) provided. (See Fig. 1)
- Thread the SCREW COLLAR LOOP (6) onto the bottom end of the NIPPLE (4). Place the CANOPY (15) over the OUTLET BOX (1) and adjust the SCREW COLLAR LOOP (6) and NIPPLE (4) until the midpoint of the outside threads on the SCREW COLLAR LOOP (6) is centered (aligned) with the surface of the CANOPY (15). Remove the CANOPY (15) and tighten both 1/8" IPS HEX NUTS (5) down on the MOUNTING BRACKET (2) and the SCREW COLLAR LOOP (6). (See Fig. 1)
- Thread the FIXTURE LOOP (19) onto the CENTER NIPPLE (20). (See Fig. 2)
- Attach two CLOSABLE LINKS (18) to each end of the CHAIN (17), and then attach one CLOSABLE LINK (18) onto the FIXTURE LOOP (19). Slide the THREADED RING (16) and the CANOPY (15) onto the CHAIN (17) (in that order) and attach the other CLOSABLE LINK (18) to the SCREW COLLAR LOOP (6). (See Fig. 1 and 2)
- Unravel the fixture lead wires (10 and 12) and FIXTURE GROUND WIRE (7) and thread them through every other link of the CHAIN (17) starting with the chain link attached to the FIXTURE LOOP (19). Feed the fixture lead wires (10 and 12) and FIXTURE GROUND WIRE (7) through the SCREW COLLAR LOOP (6) and NIPPLE (4) assembly. Pull the fixture lead wire (10 and 12) and the FIXTURE GROUND WIRE (7) upward to remove any excess slack. (See Fig. 1)
- Attach the power supply wires to the fixture lead wires by connecting the BLACK SUPPLY WIRE (9) to the SMOOTH FIXTURE LEAD WIRE (10) and the WHITE SUPPLY WIRE (11) to the RIBBED FIXTURE LEAD WIRE (12). Loop the FIXTURE GROUND WIRE (7) around the GROUND SCREW (14) of the MOUNTING BRACKET (2). (Note: Be sure to provide an extra 3" length of the GROUND WIRE (7).) Connect the remaining FIXTURE GROUND WIRE (7) to the SUPPLY GROUND WIRE (8) using a WIRE CONNECTOR (13). Place wiring and connections inside the OUTLET BOX (1). (See Fig. 1)

ASSEMBLY AND INSTALLATION (Continued)

- Slide the CANOPY (15) and the THREADED RING (16) up the CHAIN (17). Place the CANOPY (15) over the OUTLET BOX (1) and secure it in place by screwing the THREADED RING (16) onto the SCREW COLLAR LOOP (6). (See Fig.1)
- Slide the CANDLE SLEEVES (22) over the SOCKETS (23).
- Screw light bulbs into the sockets and make sure they do not exceed the maximum wattage specified on the fixture's wattage rating label, **MAXIMUM 60W.**

INSTALLATION IS NOW COMPLETED

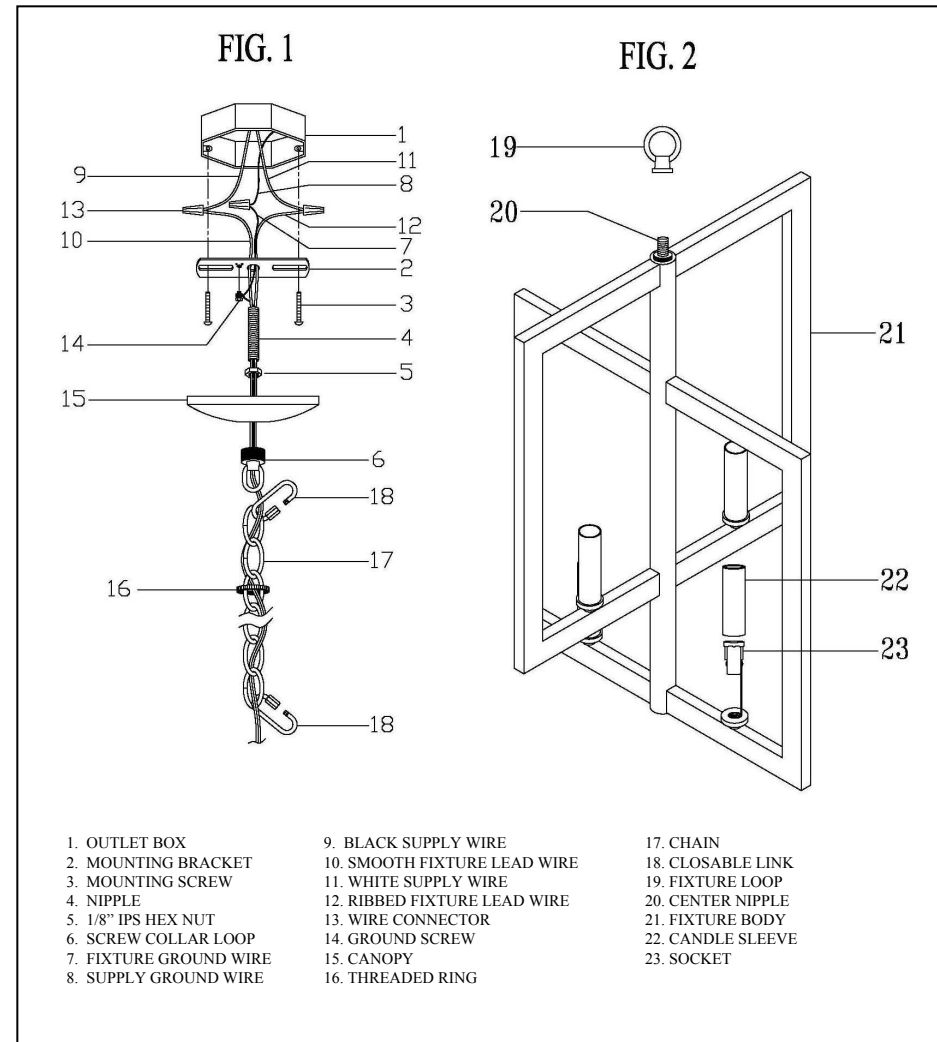

Craftmade Brands Lighting Limited Warranty

Craftmade Brands warrants all its Products to be free from defects in material and workmanship, subject to certain conditions and exclusions, for period of one year from the date the Product was shipped to the original end use purchaser. Craftmade Brands will warranty its product only if it is sold through an authorized Craftmade Brands dealer.

Craftmade Brands will, at its discretion, repair, replace or make appropriate adjustment where inspection discloses any defects occurring in normal usage within the applicable time period above, subject to the following conditions and exclusions.

The following costs, expenses and damages are not covered by the provisions of this limited warranty: (1.) labor costs including, but not limited to, costs associated with the removal and reinstallation of Product; (2.) shipping and freight expenses required to return Product to Craftmade Brands.

All warranties only apply to the original end use purchaser and original installation of Products. **This warranty is not transferable.** The provisions of this warranty do not apply to products that are used in commercial applications; used for purposes for which they are not designed or intended; which have been subjected to alteration, accidental damage, abuse, misuse, negligence or accident; which have been improperly stored, installed, maintained or operated; which have been used in violation of written instructions provided by Craftmade Brands; which have been subjected to improper temperature, humidity or other environmental conditions; or which, based on examination by Craftmade Brands, do not disclose to the satisfaction of Craftmade Brands non-conformance to the warranty. Additionally, this warranty **DOES NOT COVER** scratches, abrasions, or deterioration due to the use of paints, solvents, chemicals or abrasive cleaning techniques.

The above warranties also do not apply if:

The original bill of sale, delivery date, or product number cannot be verified.

The parts claimed to be defective are not returned for inspection if so requested by Craftmade Brands. The product is not in the possession of the original end use purchaser at the time warranty claim is made.

To obtain Warranty Service, please contact Craftmade Brands through your Lighting Dealer, Lighting Contractor, or by writing Craftmade Brands, Attn: Customer Service Department, 650 South Royal Lane, Coppell, TX 75019, or by calling 800.486.4892

Warranty Exclusions:

Craftmade Brands uses the best weather resistant finishes; nevertheless, finishes for fixtures installed outdoors are subject to change due to prolonged exposure to sunlight, pollutants and other environmental conditions. Any claim for fading, discoloration or "patina" of a finish on an outdoor fixture is not applicable to the above warranty. See the "Finish Care & Cleaning" instructions below for proper care and maintenance of your fixture.

The environment within ten miles of a sea coast can be extremely corrosive. Even with the appropriate maintenance, products installed in this environment will typically deteriorate more than products installed in a less severe environment. Some corrosion and/or deterioration is considered "normal wear" in this environment. Any claim for finish failures or for corrosion of other components due to coastal environment conditions is not applicable to the above warranty.

We cannot warranty our Direct Burial Poles due to environmental issues such as moisture, soil acidity and other corrosive soil and air conditions.

Craftmade Brands strives to assure that glass and metal finishes shown in our catalogs match the actual product, but chemical finish variations and hand applied finishes can result in differences between the actual product and printed images.

Craftmade Brands does not authorize any person to create for it any obligation or liability in connection with its Products. The maximum liability is limited to the original purchase price of the product. No action arising out of any claimed breach of this warranty by Craftmade Brands may be brought by the Original User more than one (1) year after the cause of action has arisen. IMPLIED WARRANTIES INCLUDING THAT OF MERCHANTABILITY AND FITNESS FOR A PARTICULAR PURPOSE ARE EXPRESSLY LIMITED TO THE DURATION OF THIS WARRANTY. CRAFTMADE BRANDS AND/OR SELLER DISCLAIMS ANY LIABILITY FOR SPECIAL, INCIDENTAL OR CONSEQUENTIAL DAMAGES.

This warranty gives you specific legal rights, and you may also have other rights which vary from state to state. Some states do not allow limitations on incidental or consequential damages or how long an implied warranty lasts, so that the above limitations may not fully apply to you. Refer to your local laws for your specific rights under this warranty.

CARE & CLEANING: Initial care for finishes requires periodic cleaning with a soft cloth, dampened with water. A mild non-abrasive soap may be used along with a soft cloth and water if the fixture is very dirty. Particular care should be taken to avoid abrasive materials and strong cleaning agents as they will quickly destroy the protective coatings and subject the finish to oxidation and discoloration.